

OPERATOR'S MANUAL

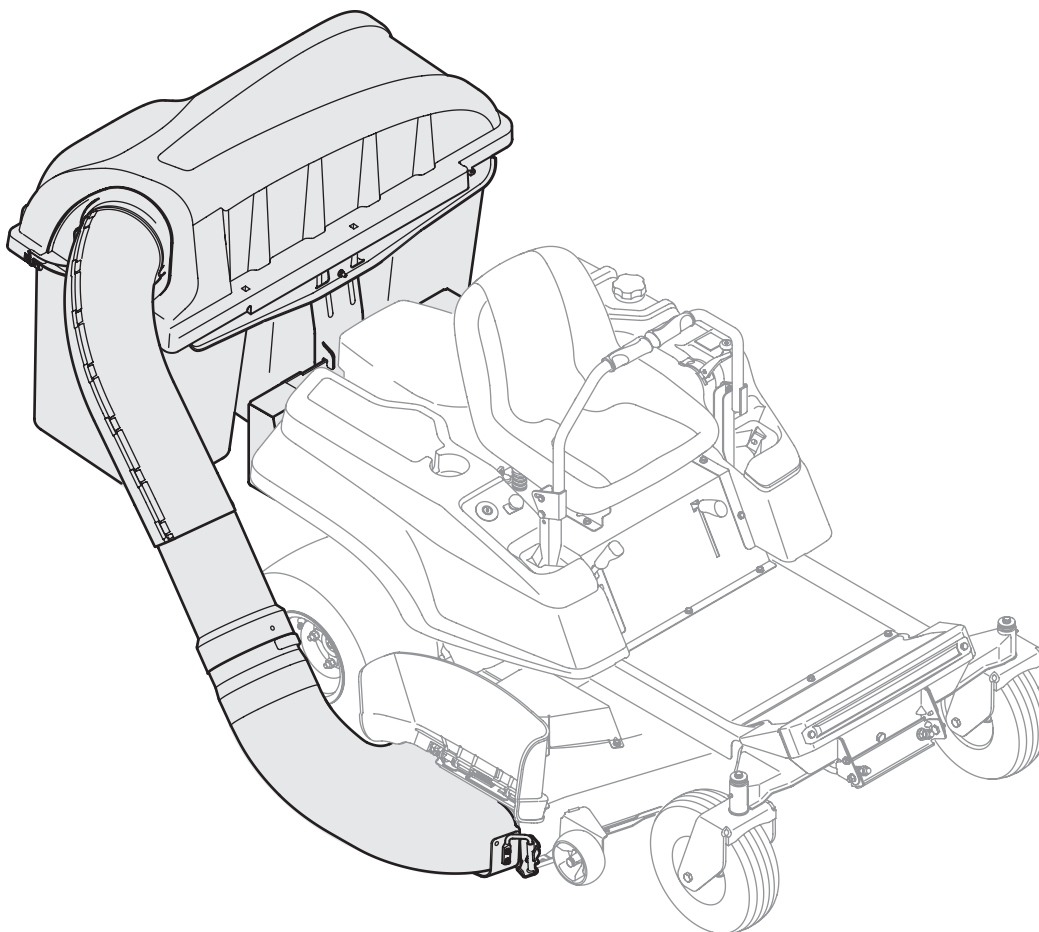

Triple Rear Bagger - Model No. 19A70008OEM

⚠ WARNING

**READ AND FOLLOW ALL SAFETY RULES AND INSTRUCTIONS IN THIS MANUAL
BEFORE ATTEMPTING TO OPERATE THIS MACHINE.
FAILURE TO COMPLY WITH THESE INSTRUCTIONS MAY RESULT IN PERSONAL INJURY.**

MTD LLC, P.O. BOX 361131 CLEVELAND, OHIO 44136-0019

19A700080EM Parts List

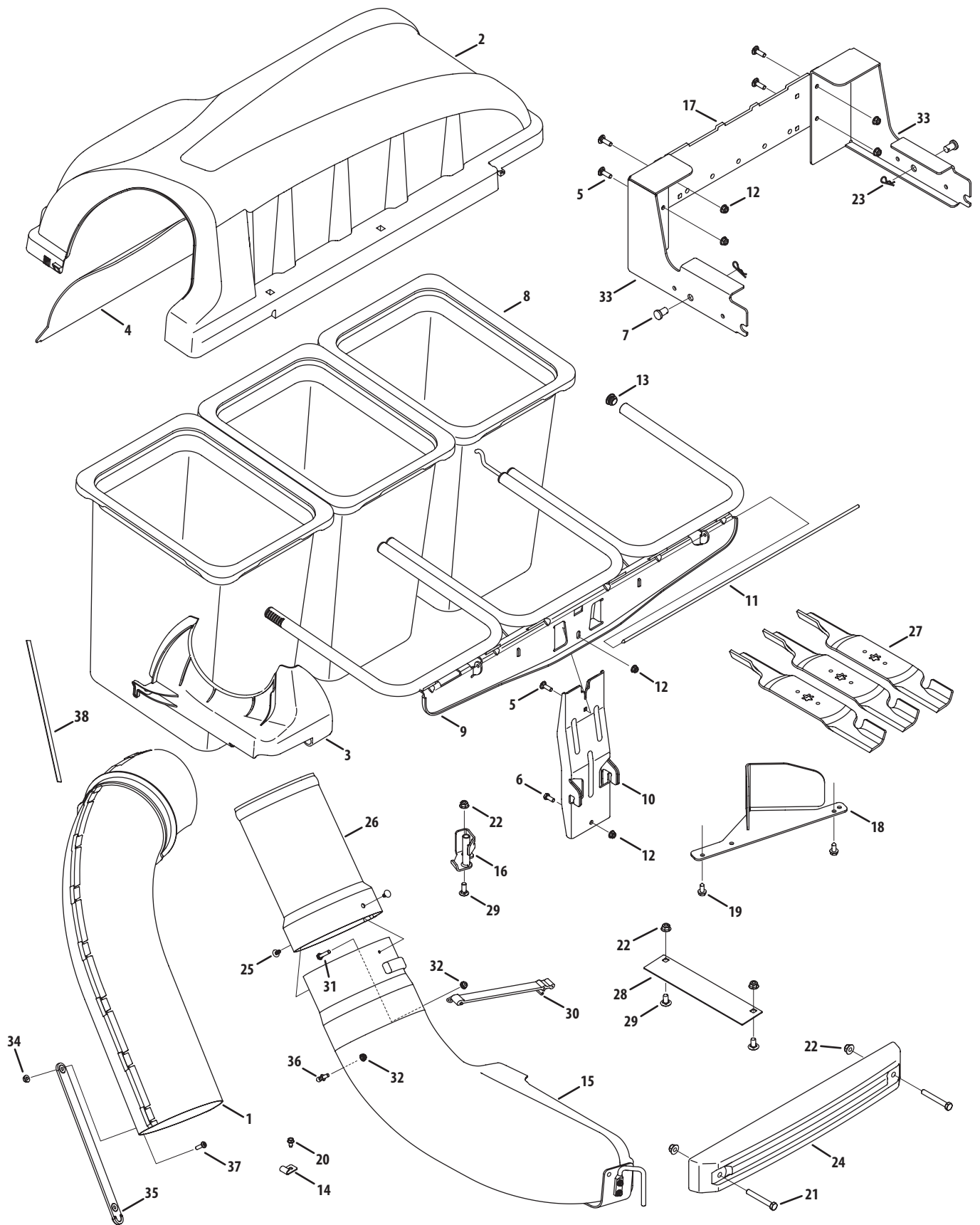

Ref.	Part Number	Description
1.	631-04295A	Upper Chute Assembly
2.	631-04298P	Triple Bagger Cover Assembly
3.	731-06497	Upper Chute Support
4.	731-06504	Bagger Cover Screen
5.	710-0276	Carriage Screw, 5/16-18 x 1.00"
6.	710-3008	Hex Head Screw, 5/16-18 x .75"
7.	911-0332	Clevis Pin, .50" Dia. x .78 Lg.
8.	964-04096	Grass-bag Assembly
9.	683-04498-0637	Triple Bag Support Assembly
10.	683-04519-0637	Vertical Support Bracket
11.	711-05079	Cover Hinge Pin
12.	712-04063	Flange Lock Nut, 5/16-18
13.	735-0246A	End Plug
14.	96606	Retainer Hook
15.	631-04300A	Discharge Chute Elbow
16.	683-0617A-0637	Chute Stop-Bracket
17.	783-06168-0637	Universal Mounting Bracket
18.	703-06018A-0637	Deck Baffle
19.	710-04484	Tap Screw, 5/16 - 18 x .750
20.	710-0599	Tap Screw, 1/4 - 20 x .500
21.	710-3022	Hex Head Screw, 3/8 - 16 x 2.75
22.	712-04065	Flange Lock Nut, 3/8 - 16
23.	914-04023	Cotter Pin, .080 x 1.5625 Internal
24.	719-04271A	RZT Bagger Weight
25.	726-3046	Ratchet Clip, .250
26.	731-06611	Bagger Chute Adapter, 7 In.
27.	942-0679	Blade, 18.50 Lg., High Lift
28.	783-06418-0637	Chute Discharge Plate
29.	710-3168	Carriage Bolt, 3/8-16 x 1.00
30.	723-0476	Chute Strap
31.	710-3015	Hex Head Screw, 1/4-20 x .75
32.	712-04064	Flange Lock Nut, 1/4 - 20
33.	689-00111	RZT Mounting Assembly (Incl. Ref No. 17 & 33)
34.	912-3027	Flange Lock Nut, 1/4-20
35.	723-04009A	Chute Strap
36.	911-04069	Grass-catcher Pin
37.	710-0924	Machine Screw, 1/4-20
38.	721-04388	Adhesive Strip